

Collection	Finish	Product
Interiors	TBC	Toggle Switch - Retract to centre

Interiors - Toggle Switch - Retract to centre

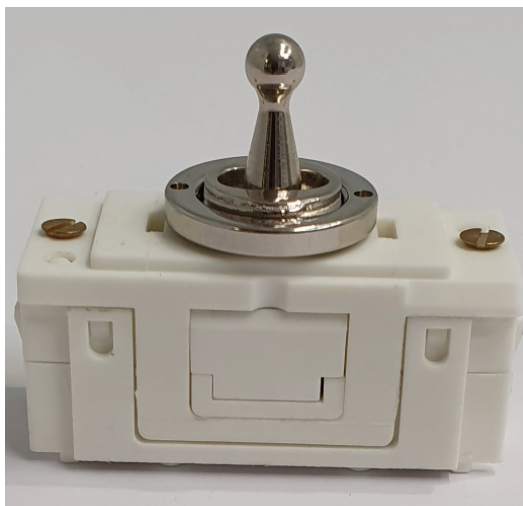

Standard style lever shown

Description

A Toggle switch interior suitable for all our major Collections. For use with Wandsworth Lighting Controls and other leading manufacturers controls.

Features

- Single Pole Double Throw (SPDT), spring return to centre position.
- Suitable for use with Wandsworth Controls WLC units including all WLC dimmers other than rotary type dimmers..
- Ideal for use with a wide range of blinds/curtains/Velux windows/dimming system controls.
- All terminal and fixing screws are operated by one-sized screwdriver.

Standards and Approvals

Certified to BSEN 60669-1 : 2018 when assembled to Wandsworth plates and grids and installed correctly.

Ordering

When ordering please state your switch type followed by finish.

E.g.

97/PB - Standard toggle lever in Polished brass

or

BATON/97/SB - Baton toggle lever in Satin brass

Back box depth - 35mm minimum

Catalogue Numbers

Reference	Unit	Lever Type
97/*	Retract To Centre Toggle - 2 Amp	Standard
BATON/97/*	Retract To Centre Toggle - 2 Amp	Baton
CORNET/97/*	Retract To Centre Toggle - 2 Amp	Cornet
PINNACLE/97/*	Retract To Centre Toggle - 2 Amp	Pinnacle
STRAIGHTKNURL/97/*	Retract To Centre Toggle - 2 Amp	Straightknurl
E32/*	Spare Ring	

Please note this switch is used to operate dimmer and blind controls and is not a dimmer switch.

Collection	Finish	Product
Interiors	TBC	Toggle Switch - Retract to centre

STANDARD LEVER
Catalogue Number:
97/*

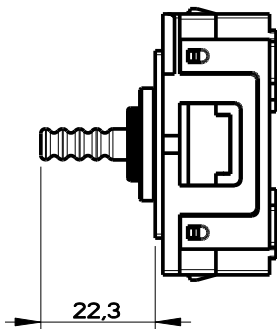
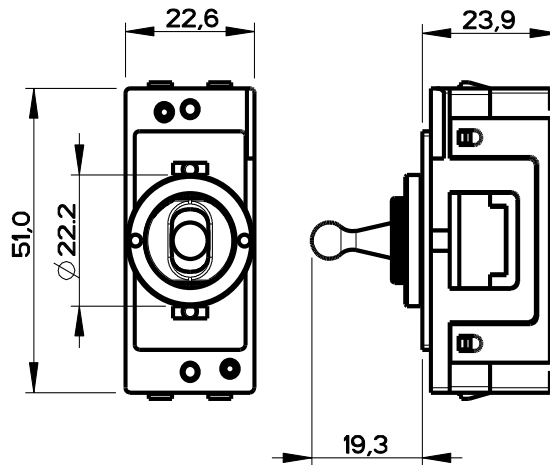

BATON LEVER
Catalogue Number:
BATON/97/*

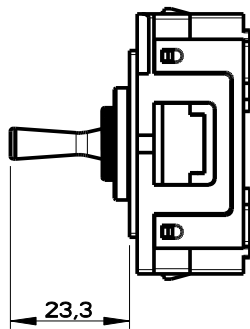

CORNET LEVER
Catalogue Number:
CORNET/97/*

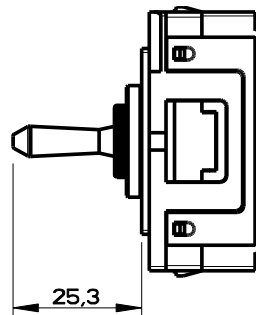

PINNACLE LEVER
Catalogue Number:
PINNACLE/97/*

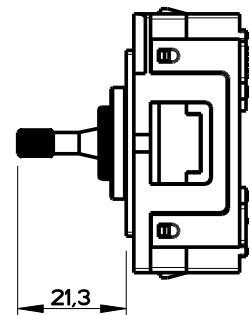

STRAIGHTKNURL LEVER
Catalogue Number:
STRAIGHTKNURL/97/*

TECHNICAL SPECIFICATIONS

	Retract to Centre Toggle
Voltage rating	250V AC, 50Hz
Current rating	2A
Operating temperature	-5°C to 40°C
IP rating	IP2XD
Max. Installation altitude	2000 Metres
No. of Operations	40,000
Terminal capacities	4 x 1mm ² (solid)
	4 x 1.5mm ² (solid)
	3 x 2.5mm ² (solid)
	2 x 4mm ² (solid)
	1 x 6mm ² (solid)

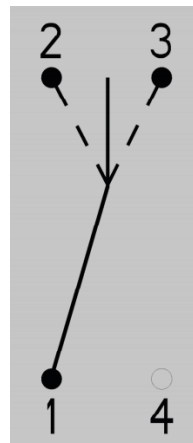

TERMINAL DESIGNATION:

NOTE: TERMINAL 4 IS NOT USED

NOTE:

The Company Policy is one of continuous improvement and the right to change designs, dimensions, descriptive matter, etc. at any time without notice is reserved.